

IGNITION

TRANSFORMERS



Allanson

DEPENDABLE

POWER



INDEX

Page

Electronic Ignition Transformers3
 Production Transformers4,5,6,7,8
 Service Replacement Transformers9,10
 Industrial Gas Transformers11
 Industrial Transformers12
 Accessories12
 Base Plates Drawings13,14
 Cross Reference Chart15
 WarrantyB.C.
 Company Office AddressesB.C.

FORWARD

Founded in 1927, Allanson has over 70 years of proven reliability to offer our customers.

This catalog serves as a guide for the proper selection of your Allanson transformer requirements.

Identification of transformers follows a simple system wherein two groups of digits describe each transformer. The first group of digits is called the "Catalog" number and is a coded description of the basic electrical construction - 421 indicates standard size can, 2721 indicates small size can and 2275 indicates electronic unit. The second group of digits is called the "Type" number and is a coded description of the mounting details.

Our BT series is a comprehensive collection of interchangeable standard can replacement transformers for use with interchangeable plates.

ELECTRICAL SPEC.	PRIMARY POWER	CATALOG NO.	TYPICAL TYPE NO.
10,000 Volt Mid Point Ground	120 Volt 60Hz	421	104
10,000 Volt MPG Small Series	120 Volt 60Hz	2721	619
6,000 Volt One End Ground	120 Volt 60Hz	1092	"F"
12,000 Volt Mid Point Ground	120 Volt 60Hz	2714	633
17,500 Volt Mid Point Ground	120 Volt 50/60 Hz	2275	628A

ELECTRONIC TRANSFORMERS

120 Volt Primary, 50/60 Hz, 17,500 Volt Secondary, 23mA, MPG

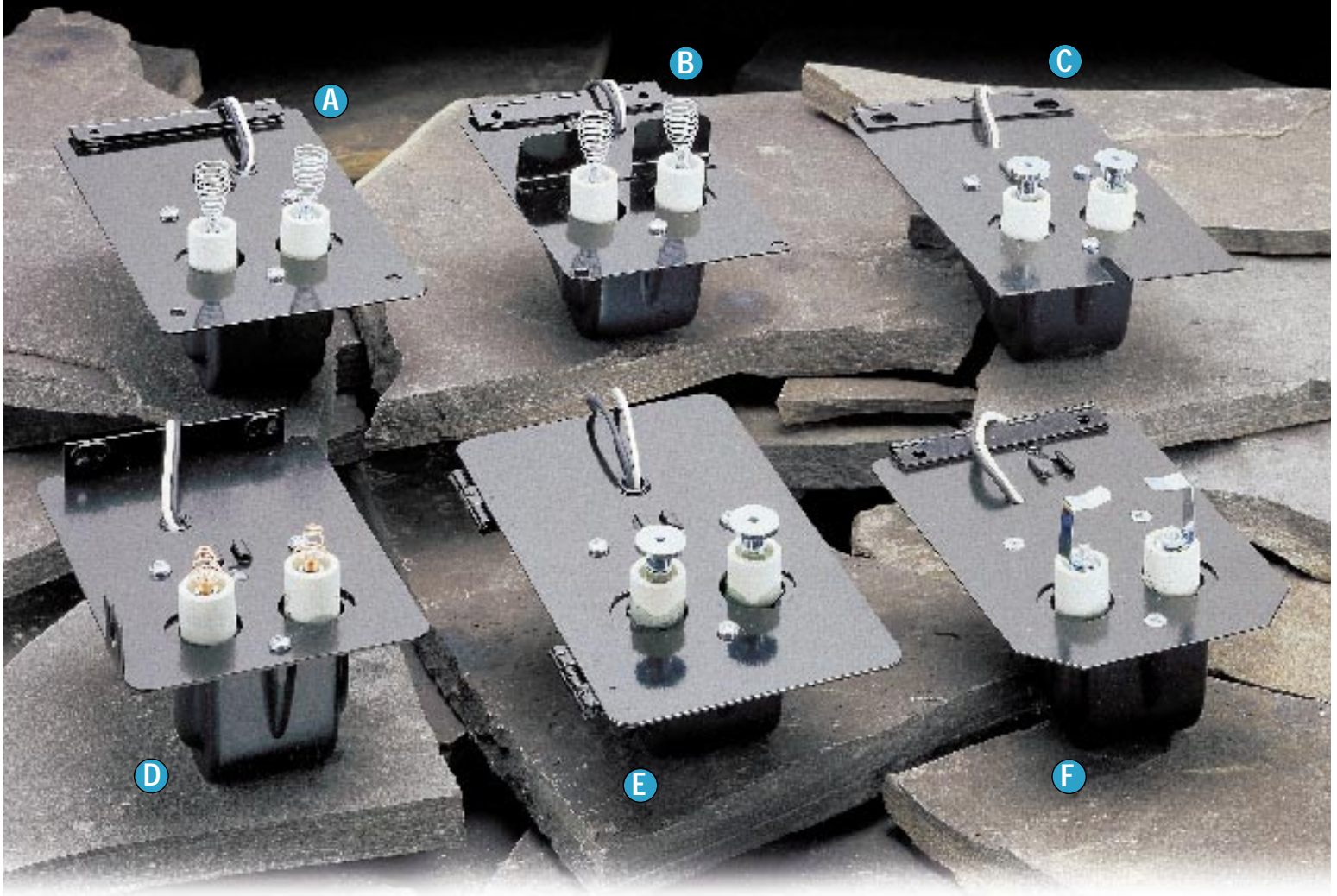

A CAT 2275 TYPE 605, BECKETT S

B CAT 2275 TYPE 628, BECKETT A, AF, AFG*
* AFG complete with gaskets

C CAT 2275 TYPE 456, AERO

D CAT 2275 TYPE 619, WAYNE HI SPEED M/MH

E CAT 2275 TYPE 620, WAYNE

F CAT 2275 TYPE 630, CARLIN 99, 100, 101, CRD

ELECTRONIC TRANSFORMER KIT INCLUDES:

CAT 2275 ELECTRONIC TRANSFORMER, 2 UNITS

ONE OF EACH OF THE FOLLOWING MOUNTING PLATES:

2600 AERO

2601 BECKETT S

2604 BECKETT A, AF

2605 CARLIN 99, 100, 101

2602 WAYNE HI SPEED M/MH

2603 WAYNE E

2606 WAYNE BLUE ANGEL

ONE 54-740 UNIVERSAL CONTACT REPLACEMENT KIT

PRODUCTION TRANSFORMERS

120 Volt Primary 60 Hz, 10,000 Volt Secondary, 23mA, MPG



A CAT 2721 TYPE 631A, ABC SUNRAY

Webster: 313-25AB86, France: 5LAY-02

B CAT 2721 TYPE 411, ABC SUNRAY

Webster: 313-25AB59, France: 5LAY-20

C CAT 2721 TYPE 409, ABC CRANE

Webster: 313-25AB73, France: LKR-2

D CAT 2721 TYPE 457, ACME HEET WEATHERALL

Webster: 3-25AB-AH, France: 5LAY-11

E CAT 2721 TYPE 456, AERO

Webster: 3-24XAB-AER, France: 5LAY-56

F CAT 2721 TYPE 452, ABC D & LC

Webster: 313-25AB65

PRODUCTION TRANSFORMERS

120 Volt Primary 60 Hz, 10,000 Volt Secondary, 23mA, MPG



A CAT 2721 TYPE 629, CARLIN, 17.5 FR,
200, 201, 500, 501 CRD

Webster: 313-24AB81, France: 5LAY-16

B CAT 2721 TYPE 630, CARLIN, 99,100,
101 CRD MISER

Webster: 313-28AB85, France: 5LAY-15

C CAT 2721 TYPE 589, GRIMSBY

D CAT 2721 TYPE 627, BROCK

E CAT 2721 TYPE 605, BECKETT S

Webster: 3-28AB-BS, France: 5LAY-05

F CAT 2721 TYPE 628, BECKETT A, AF
FOR GASKETTED AFG UNITS,
ORDER #2721-628G

Webster: 3-28AB-BAF, France: 5LAY-04

G CAT 2741 TYPE 658, BECKETT AFII

UL Recognized

Webster: 3-32AB-BAF

PRODUCTION TRANSFORMERS

120 Volt Primary 60 Hz, 10,000 Volt Secondary, 23mA, MPG



A CAT 2721 TYPE 448, NU WAY (LARGE PLATE)

Webster: 313-24AB80

B CAT 2721 TYPE 572, NU WAY (SMALL PLATE)

Webster: 313-24AB82

C CAT 2721 TYPE 069, JOHN WOOD

D CAT 2721 TYPE 368M, METRO

E CAT 2721 TYPE 619, WAYNE HI SPEED MODEL M/MH

Webster: 313-28AB91, France: 5LAY-03

F CAT 2721 TYPE 620, WAYNE E

Webster: 313-25AB78, France: 5LAY-30

G CAT 2721 TYPE 647, WAYNE BLUE ANGEL EAGLE ONE

Webster: 313-28AB205W, France: 5LAY-31

PRODUCTION TRANSFORMERS

120 Volt Primary 60 Hz, 10,000 Volt Secondary, 23mA, MPG

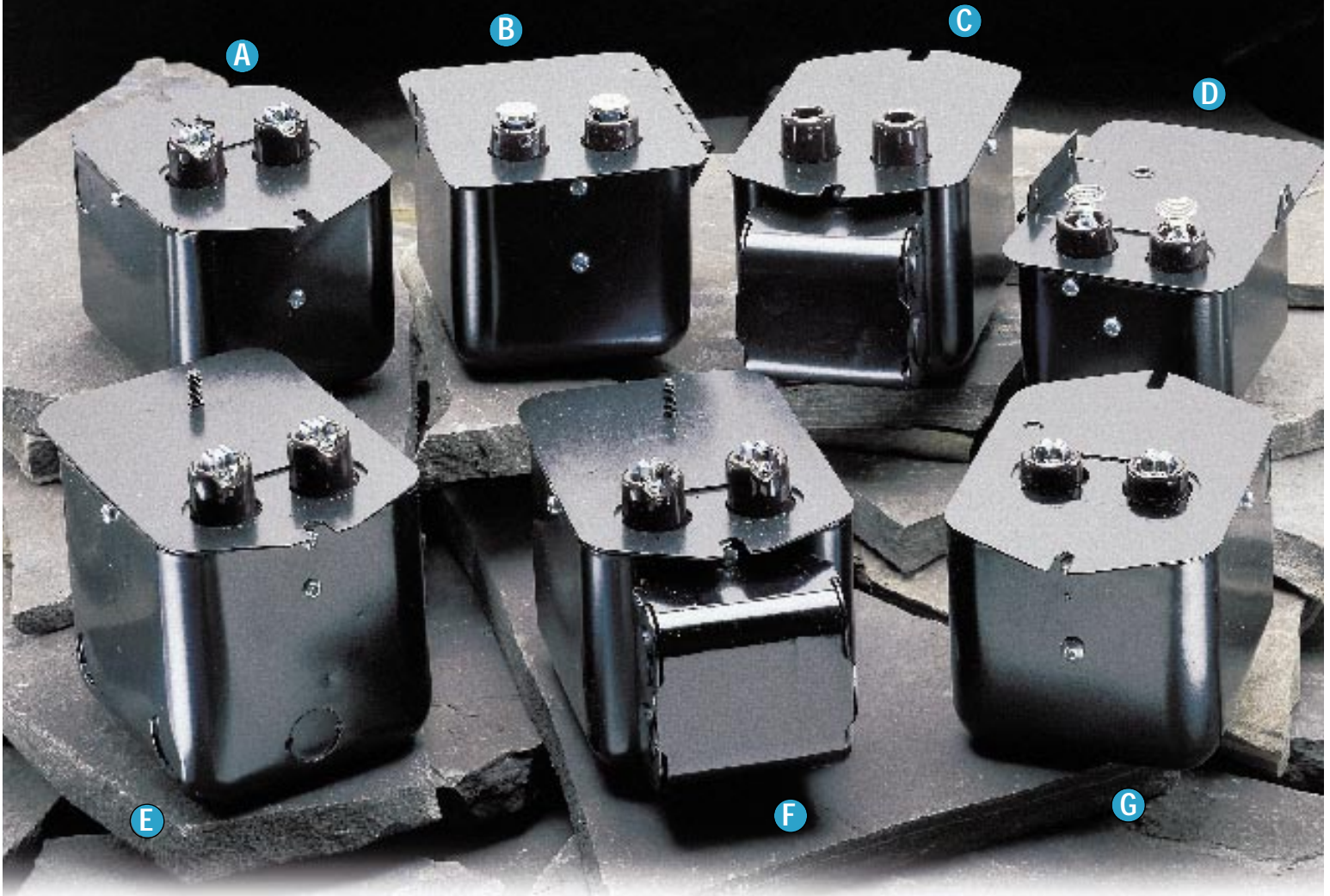

A CAT 421 TYPE 104E, AERO,
METAL MASTER, SUNRAY

Webster: 312-26AB022

B CAT 421 TYPE 254A, BARRIERE

C CAT 421 TYPE 340, ARMSTRONG/ESSO

Webster: 312-25ABE1, France: LGPW-2

D CAT 421 TYPE 558, CONROY

E CAT 421 TYPE 216, ARCO AMERICAN STANDARD

F CAT 421 TYPE 557, ARCO AMERICAN STANDARD

Webster: 312-26ABE23, France: LGHW

G CAT 421 TYPE 104, ACME/QUIET HEET

France: LGNV

PRODUCTION TRANSFORMERS

120 Volt Primary 60 Hz, 10,000 Volt Secondary, 23mA, MPG

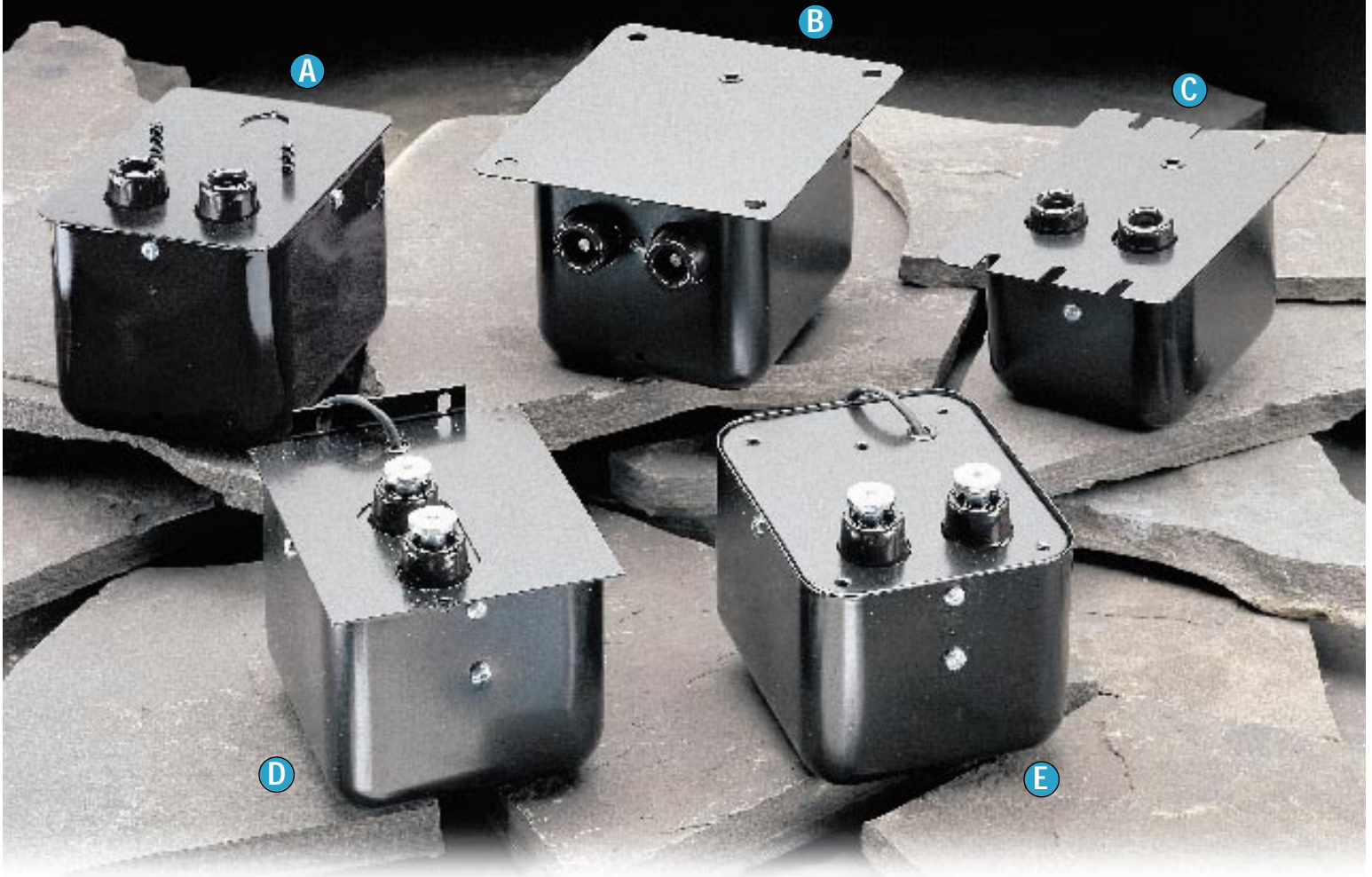

A CAT 421 TYPE 655, POWER FLAME

Webster: 312-25AB0418

B CAT 421 TYPE 659/660, CLEAVER
BROOKS/INDUSTRIAL COMBUSTION

Webster: 312-08A097 / 312-810169

C CAT 2721 TYPE 661, GORDON PIATT

Webster: 313-25AB100

D CAT 421 TYPE 331, LENNOX

Webster: 313-25AB62

E CAT 421 TYPE 430, DUCANE

Webster: 313-25AB90, France 5LAY-06

SERVICE REPLACEMENT TRANSFORMERS

120 Volt Primary 60 Hz, 10,000 Volt Secondary, 23mA, MPG

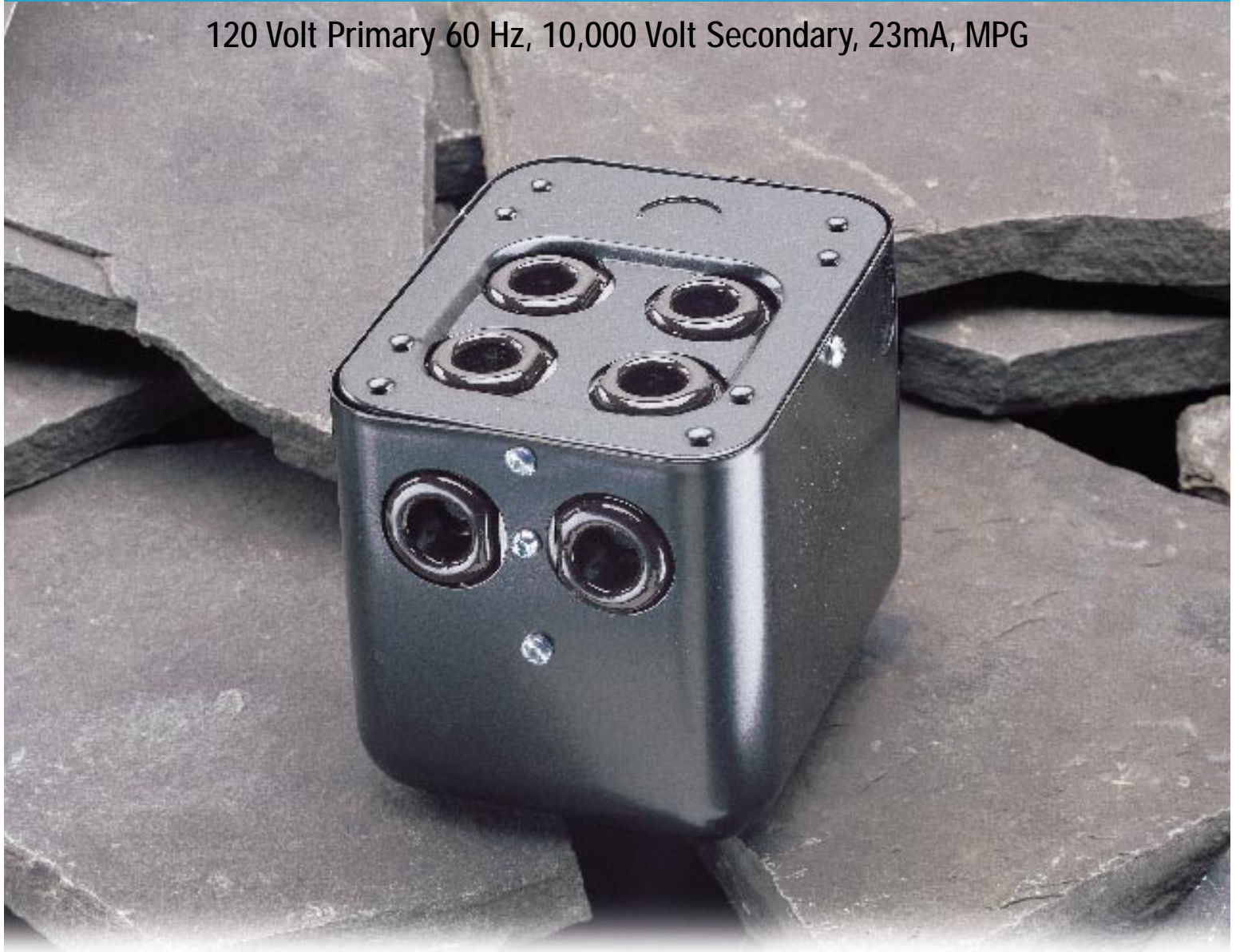

CAT 421 TYPE BT 636 COMPLETE WITH REQUIRED HARDWARE

Webster: 312-25AX0600

France: LAUV

Six Position Adaptability

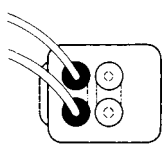

FIG. 1

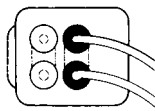

FIG. 2

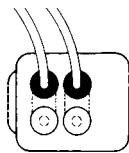

FIG. 3

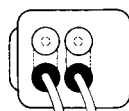

FIG. 4

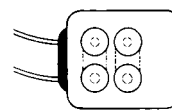

FIG. 5

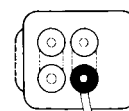

FIG. 6

ALSO AVAILABLE UPON REQUEST 5 WAY REPLACEMENT TRANSFORMER CAT 421 TYPE BT 384

SERVICE REPLACEMENT TRANSFORMERS

120 Volt Primary 60 Hz, 10,000 Volt Secondary, 23mA, MPG



A CAT 421 TYPE BT 290
Webster: 312-24AB0202, France: LGDV

B CAT 421 TYPE BT 299
Webster: 312-25A0202, France: LFBV

C CAT 421 TYPE BT 332
**ORDER CAT 421 TYPE BT 053 FOR
EXTERNAL JUNCTION BOX**
Webster: 312-25AB0202, France: LGFV

D CAT 421 TYPE BT 387
Webster: 312-24A0202, France: LFAV

E CAT 421 TYPE BT 066

F CAT 421 TYPE BT 104
Webster: 312-24AB0237, France: LGCV

G CAT 421 TYPE BT 240
Webster: 312-24ABE202, France: LGDW

INDUSTRIAL GAS TRANSFORMERS

120 Volt Primary 60 Hz, 6,000 Volt Secondary EPG



A 1092 N, RAY BURNER
Webster: 613-6A10, France: 3RAFYR-14

B 1092 PF, POWER FLAME
Webster: 612-6A056

C 1092 S, GORDON-PIATT
Webster: 612-6A020 / 612-6A072

D 1092 F
Webster: 612-6A7, France: 6EEGW-2

E 1092 H, CLEAVER BROOKS
Webster: 612-8A021

F 1092 K, DUNHAM-BUSH, IRON FIREMAN
Webster: 612-8AB017

INDUSTRIAL TRANSFORMERS

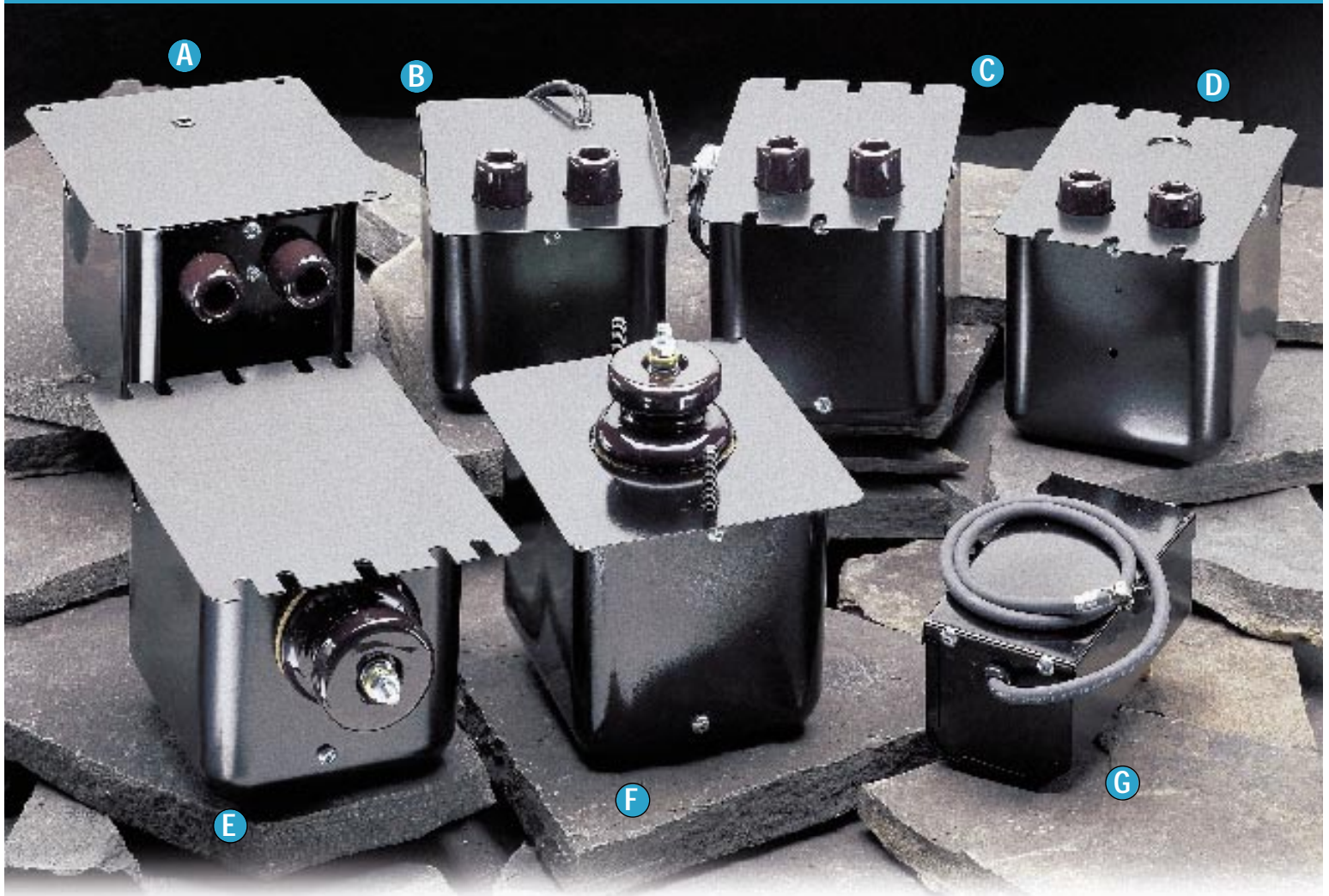

120 Volt Primary, 60 Hz, 12,000 Volt Secondary Mid Point Ground

A CAT 2714 TYPE 359, CLEAVER BROOKS

Webster: 12-8A08, France: 2KAAVS-1

B CAT 2714 TYPE 633, CARLIN

Webster: 12-8AB7, France: 2KACVS-2

C CAT 2714 TYPE 656, BECKETT

D CAT 2714 TYPE 662, GORDON-PIATT

Webster: 12-8AB02

120 Volt Primary, 60 Hz, 10,000 Volt Secondary End Point Ground

E 542 A

Webster: 312-6A0456

F 542 C

120 Volt Primary, 60 Hz, 5,000 Volt Secondary End Point Ground

G CAT 2709 TYPE 001, DESA KOEHRING,
HOMELITE AMCA CENTURY

Accessories

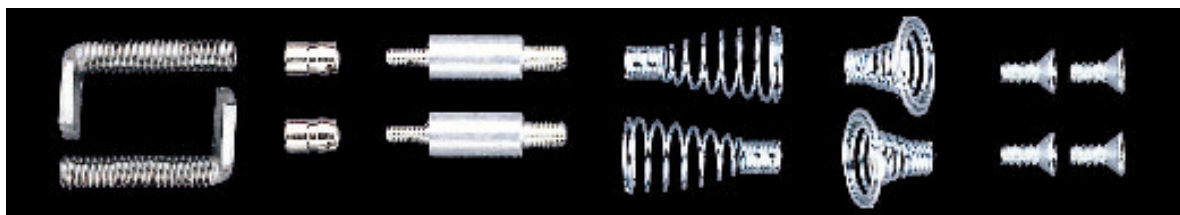

25-428

29-294

29-295

29-300

29-276

25-232

INTERCHANGEABLE BASEPLATE DRAWINGS

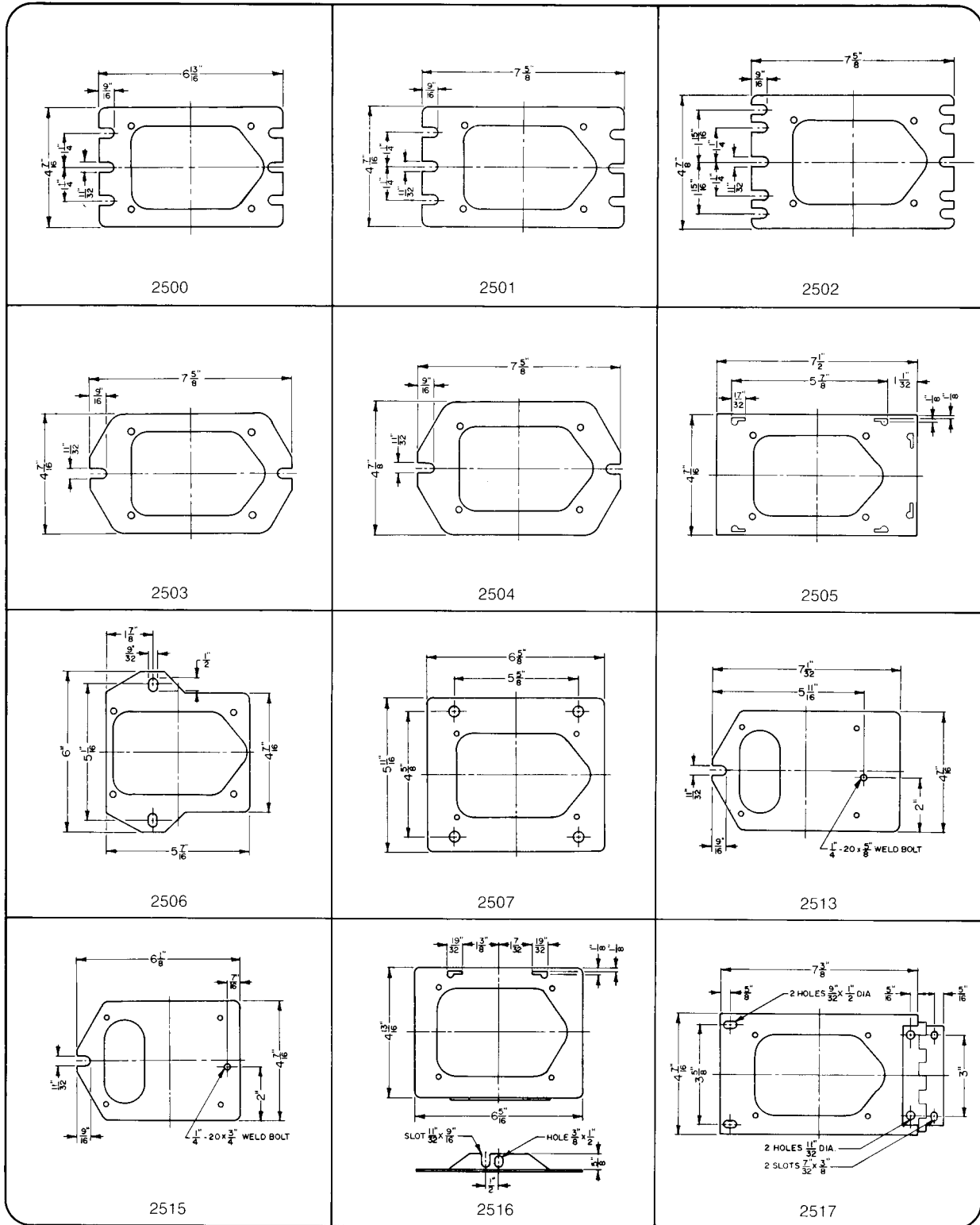

INTERCHANGEABLE BASEPLATE DRAWINGS

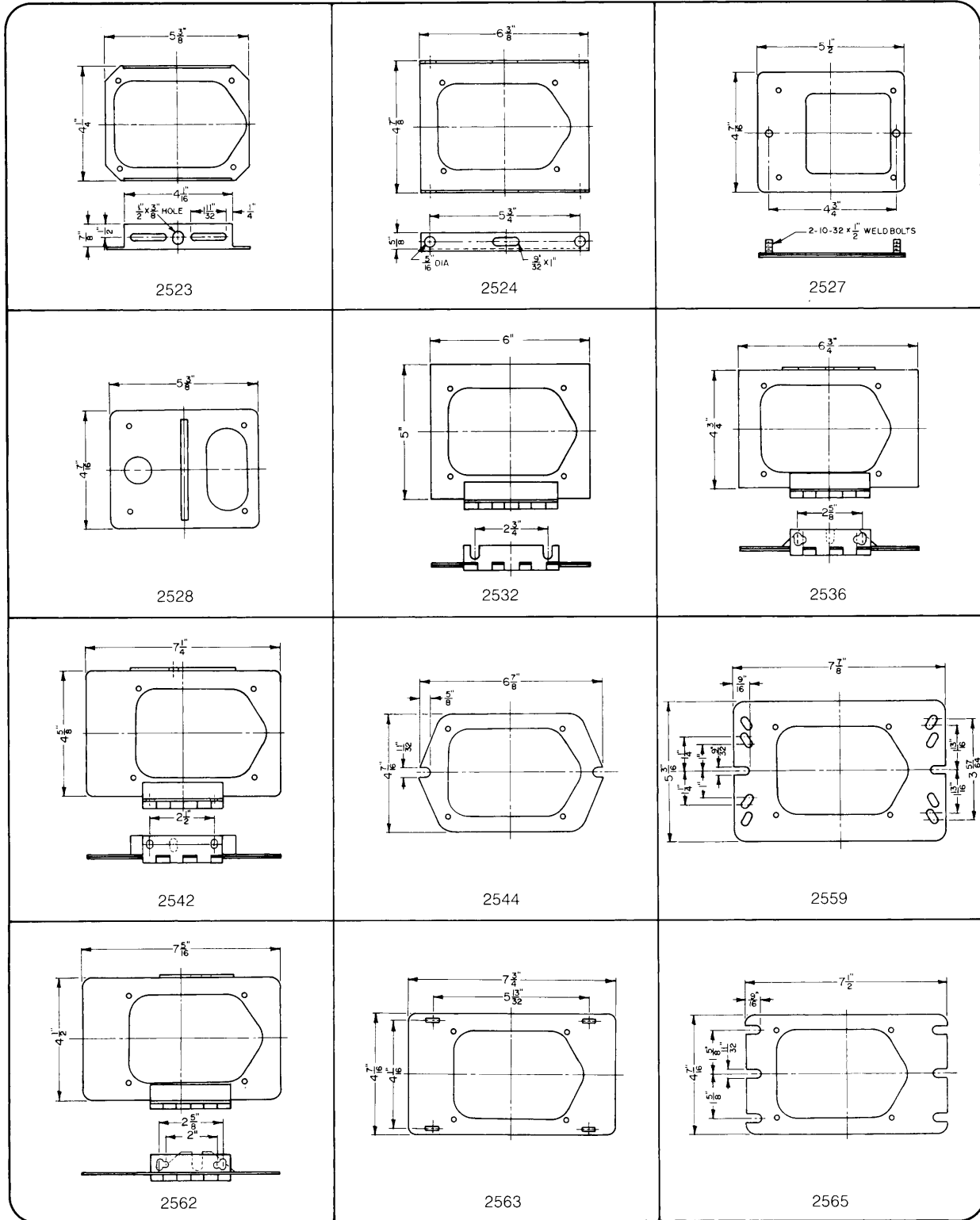

* OTHER PLATES ARE AVAILABLE UPON REQUEST.
CONTACT YOUR ALLANSON REPRESENTATIVE.

CROSS REFERENCE

BURNER MANUFACTURER	Allanson	Dongan	France	Webster	Sid Harvey	Thermolok
10,000 Volt Secondary Mid Point Ground						
ABC	2721-411	XD-AB207	5LAY-20	313-25AB59	T-84	C-792
ABC/SUNRAY	2721-631A	XD-AB201	5LAY-02	313-25AB86		TSR-10
ABC-CRANE	2721-409	A10-SV351	LKR-2	313-25AB73	T-86	C-793
ABC-D&LC	2721-452			313-25AB65	T-34-B	
ACME/QUIET HEET	421-104	A10-SR12	LGNV		T-31N	C-53
ACME-WEATHERALL	2721-457		5LAY-11	3-25AB-AH	T37	
AERO	2721-456	XD-AR211	5LAY-56	3-24XAB-AER		TA-10
ARCO/AMER.STANDARD	421-216					
ARCO/AMER.STANDARD	421-557	A10-SP18	LGHW	312-26ABE23	T-183B	C-483
ARMSTRONG/ESSO	421-340		LGPW-2	312-25ABE1	T-80-3M	
BARRIERE	421-254A					
"BECKETT A, AF"	2721-628	XD-BK103	5LAY-04	3-28AB-BAF	T-92	TB-10
BECKETT AFG	2721-628G					
BECKETT AFII	2741-658			3-32AB-BAF		
BECKETT S	2721-605	XD-BK204	5LAY-05	3-28AB-BS	T-90	TB-11
BROCK	2721-627					
CARLIN 200 201 500 CRD	2721-629	XD-CR206	5LAY-16	313-24AB81	T-95	TC-11
CARLIN 100 CRD	2721-630	XD-CR205	5LAY-15	313-28AB85	T-94	TC-10
CLEAN BURN	2721-654		5LAY59			
CLEAVER BROOKS	421-659			312-8A097		
CONROY	421-558					
DUCANE	421-430	A10-SQ182	5LAY-06	313-25AB90		
GORDON PIATT	421-661			313-25AB100		
GRIMSBY	2721-589					
INDUSTRIAL COMBUSTION	421-660			312-8A0169		
JOHN WOOD	2721-069					
LENNOX	421-331	XD-DC212		313-25AB62	T-265	C-823
METAL MASTER	421-262	A10-S32	LGM		T-28B	C-544
METRO	2721-368M					
NU-WAY (LARGE PLATE)	2721-448			313-24AB80	T-120	C-794
NU-WAY (SMALL PLATE)	2721-572			313-24AB82	T-122	C-807
POWER FLAME	421-655			312-25AB0418		
SUNRAY	421-104E			312-26AB022	T-29-10B	C-733
WAYNE (BLUE ANGEL)	2721-647		5LAY-31	313-28AB205W		
WAYNE E	2721-620	XD-WN208	5LAY-30	313-25AB78	T-88	C-799
WAYNE HI SPEED M MH	2721-619	XD-WN202	5LAY-03	313-28AB91	T-93	TW-10
12,000 Volt Secondary Mid Point Ground						
CARLIN	2714-633	A12-SV10	2KACVS-2	12-8AB7		
CLEAVER BROOKS	2714-359	A12-SJ10	2KAAS-1	12-8A08		
BECKETT	2714-656					
GORDON PIATT	2714-662			12-8AB02		
10,000 Volt Secondary Mid Point Ground						
UNIVERSAL 6 WAY	421-BT636		LAUV	312-25AX0600	T1-15	T-628
UNIVERSAL 5 WAY	421-BT384					
	421-BT053			312-24ABE203		
	421-BT066					
	421-BT104	A10-SR10	LGCV	312-24AB0237	T-31N	
	421-BT240	A10-SX10	LGDW	312-24ABE202	T-18N	C-456
	421-BT276	A10-SW10	LGEV	312-25AB0237		C-551
	421-BT290	A10-SQ10	LGDV	312-24AB0202	T-17N	C-554
	421-BT299	A10-SJ10	LFBV	312-25A0202		
	421-BT332	A10-SV10	LGFV	312-25AB0202	T17M	C-555
	421-BT387	A10-SF10	LFVAV	312-24A0202	T-21N	
INDUSTRIAL TYPE IGNITION TRANSFORMERS						
6,000 Volt Secondary One End Ground 120 Volt						
GAS APPLICATION	1092-F	A06-SA6	6EEGW-2	612-6A7	T-246N	
GORDON-PIATT	1092-S			612-6A020/612-6A072		
CLEAVER BROOKS	1092-H			612-8A021		
IRON FIREMAN, DUNHAM-BUSH	1092-K			612-8AB017		
POWER FLAME	1092-PF			612-6A056		
RAY BURNER	1092-N		3RAFYR-14	613-6A10		
10,000 Volt Secondary One End Ground 120 Volt						
OIL APPLICATION	542-A			312-6A0456		
OIL APPLICATION	542-C					

WARRANTY

Allanson agrees to correct any defects in material or workmanship which may develop in any oil burner or gas ignition transformer sold, when used under proper or normal conditions, during a period of 24 months from the date of manufacture. Such correction may be by repair, replacement, or material credit at the company's discretion.

This warranty does not include shipping costs to and from the factory. This correction shall fulfill completely any and all obligations by Allanson intended or implied by this warranty. Allanson shall not be responsible for consequential damage or for labour involved in making replacement.



CANADA: 33 Cranfield Road, Toronto, Ontario M4B 3H2
Telephone (416) 755-1191 • Fax (416) 752-6717
Toll Free **1-800-668-9162**

U.S.: 99 Adams Blvd., E. Farmingdale, NY 11735
Telephone (516) 293-3880 • FAX (516) 293-3470